

GDF60-18Z/4.5-ER25 380V接线盒外形图

接线说明图

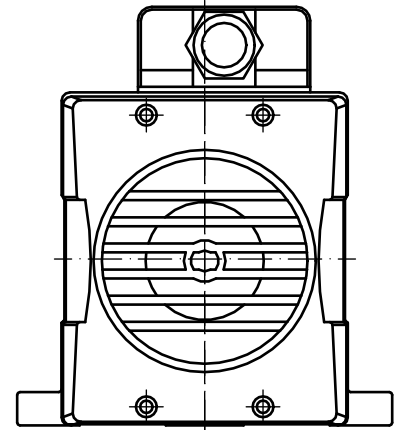
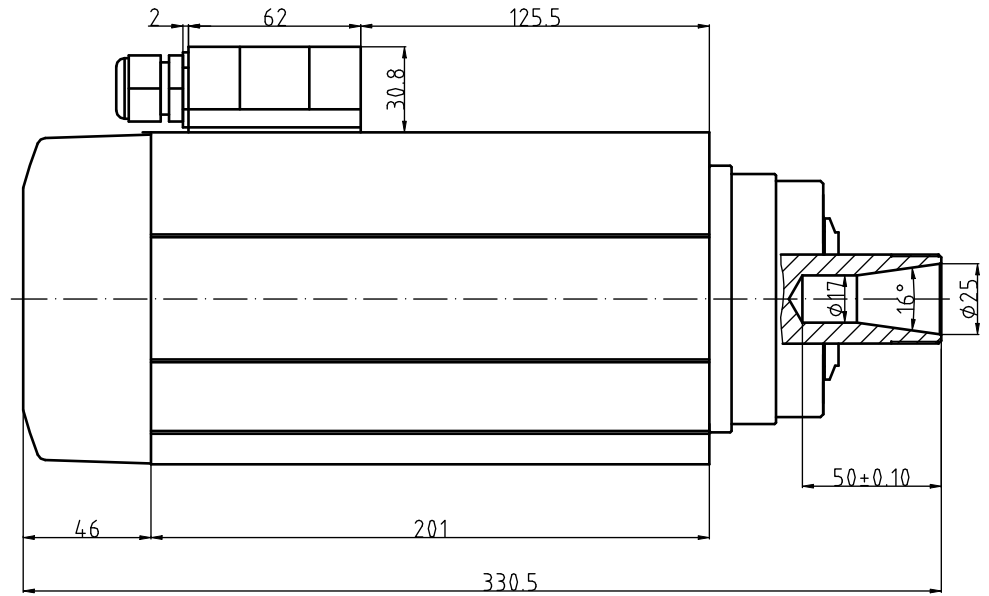
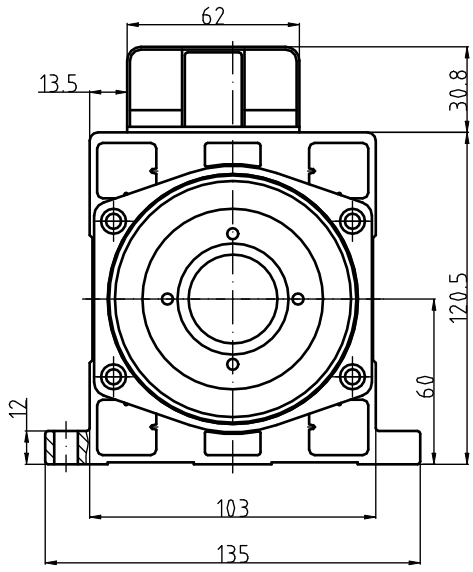
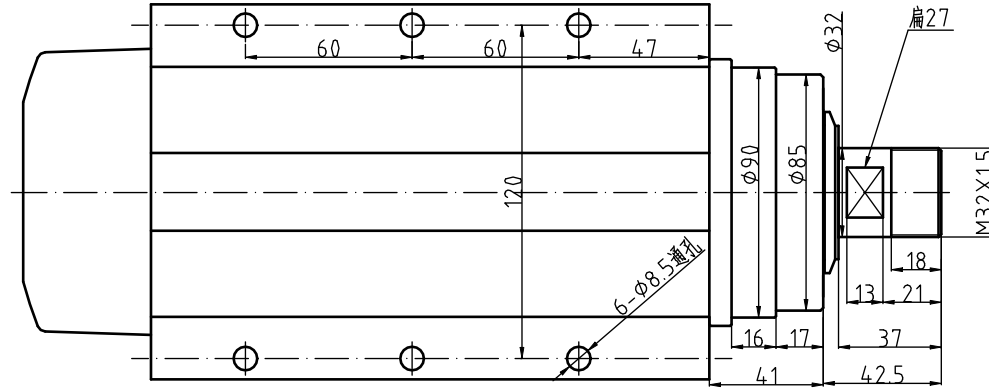
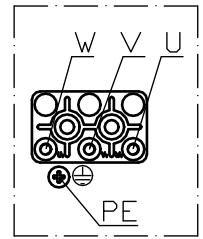

GDF60-18Z/4.5-ER25

- | | |
|---------------|---------------------------------|
| 功率 4.5kw | 重量:12KG |
| 电压 380V | ER螺帽:ER25 |
| 电流 9.0A | 冷却方式: 风冷 |
| 频率 300Hz | 轴承润滑方式: 脂润滑 |
| 转速 18000r/min | 高精度角接触球轴承:2X7007C P4/2X7002C P4 |
| | 旋转方向: 从轴伸端看为逆时针方向 |

特别注意: 按装固定螺钉时必须涂上螺纹胶或加上弹簧垫圈以防止松动!